

G-8078H-2L1C-T

Finezza Uno Series

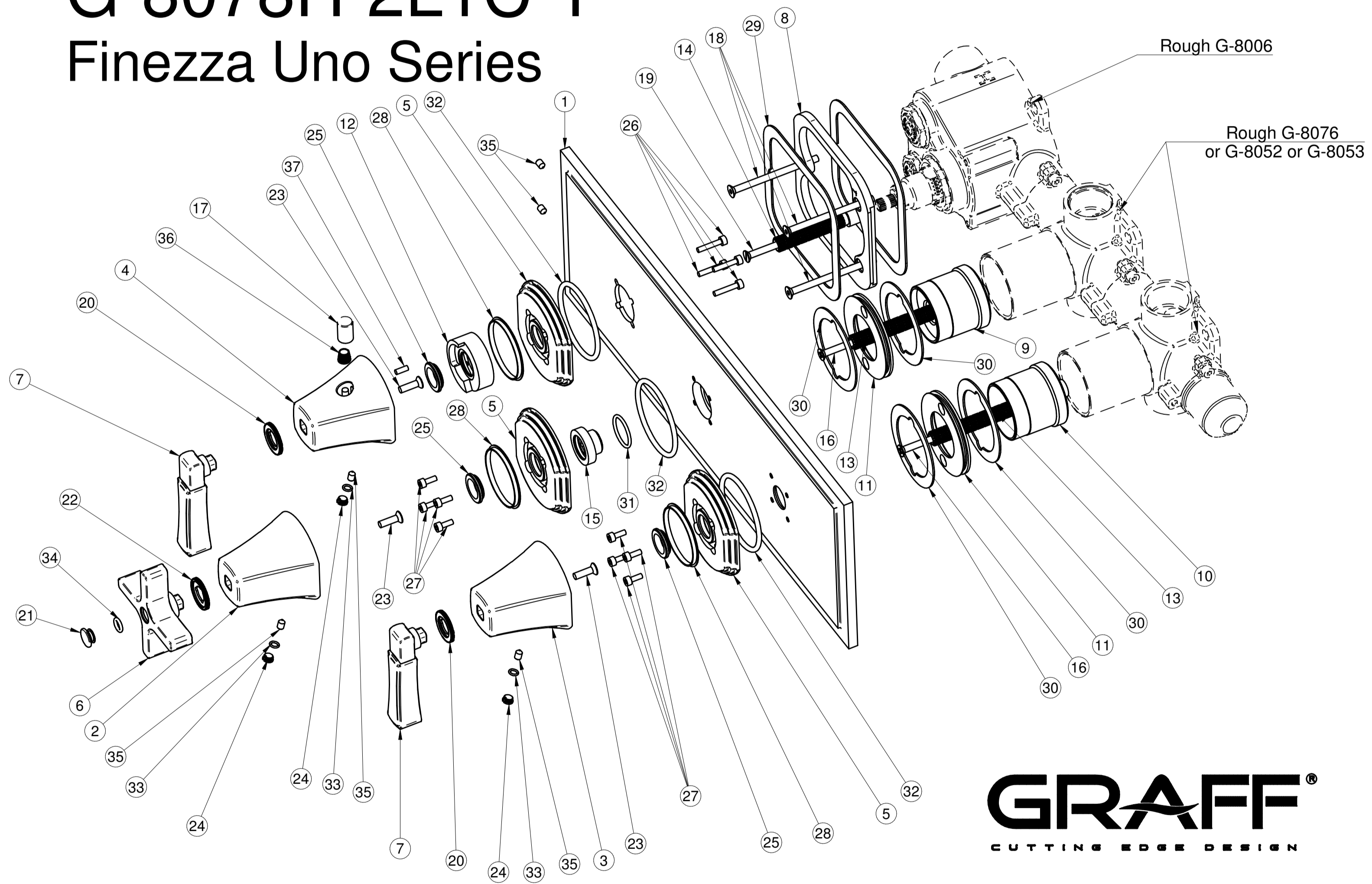

GRAFF[®]
CUTTING EDGE DESIGN